



普傑國際股份有限公司

PROFESSOR TECHNOLOGY CO., LTD.

PRODUCT SPECIFICATION

產品承認書

Customer: _____

Product Name: **5.1 Channel Surround Headphone.**

Model No: **CP5.1-CD/MP3**

Production Region: **China**

Version: **English**

Customer Approval Stamp.

Date: ___ / ___ / ___.

Contact Info: Jimmy Chan
+886-3-4551081 ext:209
jimmychan@professor.com.tw
jack@professor.com.tw

Model No:

CP5.1-CD/MP3

Date:

30/Nov/2004

Checked by:

Approved by:

PROFESSOR TECHNOLOGY CO., LTD.

5F, No.25-1, JiLin Rd., Chung-Li Industrial Park, Taoyuan 320, Taiwan.

TEL :+886-3-4551081 FAX :+886-3-4553913

Specification 規格

Part	Description	Qty.	
1.	Driver	Front: 27mm Dynamic Speaker 32 Ohm 150mW	2
		Rear: 27mm Dynamic Speaker 32 Ohm 150mW	2
		Center: 27mm Dynamic Speaker 16 Ohm 100mW	2
		Bass: 30mm Dynamic Speaker 24 Ohm 15mW	2
2.	Processor	Input: AC100~240V 50/60Hz Output: DC+5V 1A	1
3.	Headphone type	Closed Air type.	
4.	Cable & Connector	Cord Length: 240 cm	
		Connector: ø3.5mm stereo plug green color.	1
		DC Jack 2.5mm black color	1
		Accessories : ø3.5mm to ø2.5mm Stereo connector	1
5.	Weight	Gross Weight: 664 g (include accessories and package) Net Weight: 468 g (only headphone)	
6.	Package type	Blister	
7.	Power Supply	Input: AC100~240V 50/60Hz Output: DC+5V 1A DC plug: OD=5.5mm ID=2.7mm	

Cosmetic List 外觀圖清單



Power Supply



US 

1. Headphone
2. Control Box (Processor) with Volume control.
3. Stereo plug (Green)
4. DC Jack



1. $\varnothing 3.5\text{mm}$ to $\varnothing 2.5\text{mm}$ Stereo connector.

Circuit Diagram 電路圖

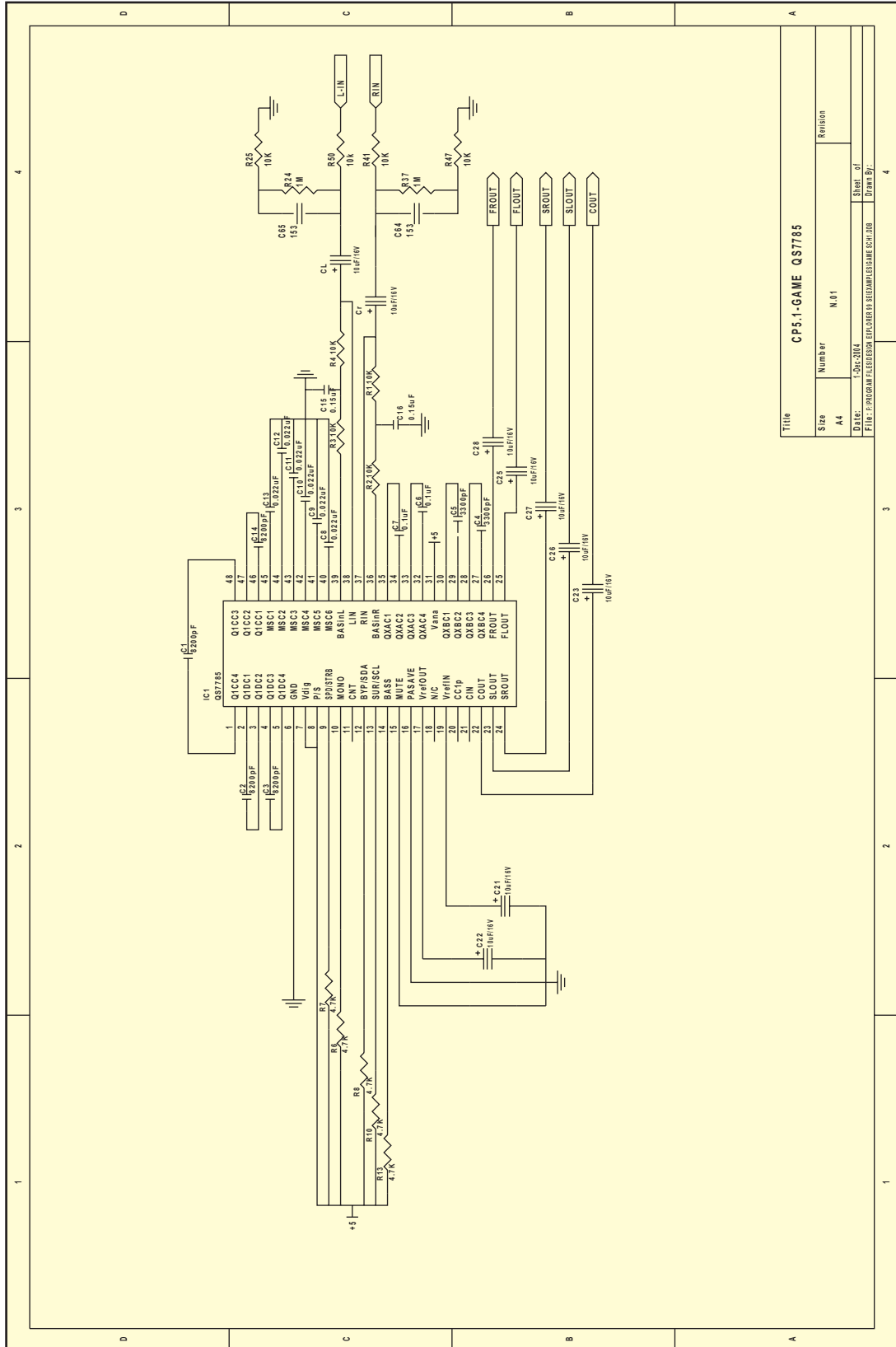

Title		CPS.1-GAME Q57785	
Size	Number	Revision	
A4	N.01		
DATE:	1 Dec 2011	SWAY-JI	4
FILE:	PROGRAM TELEVISION FOR CURRENTS TELEVISIONS ECU.100	DATE BY:	

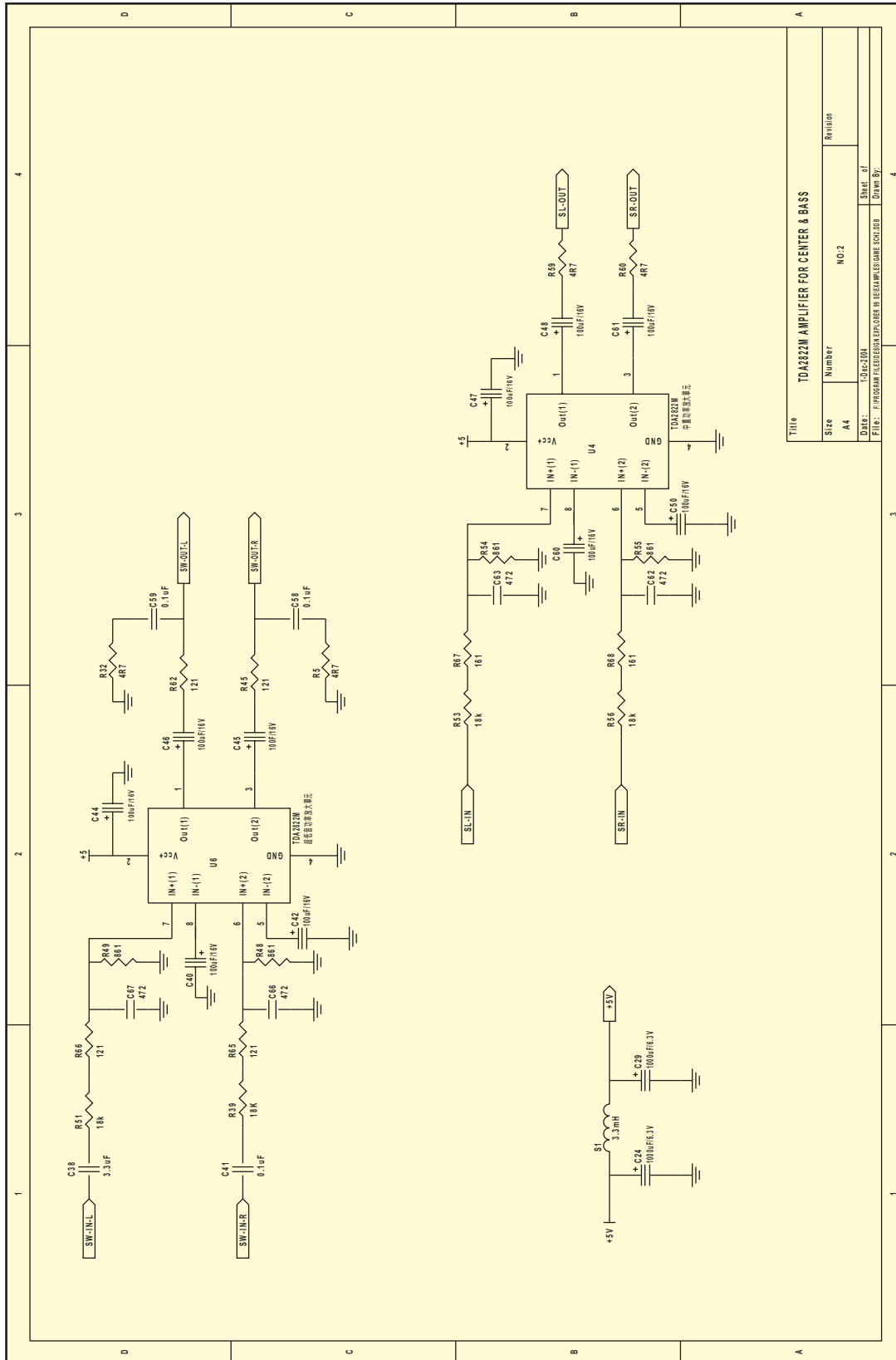

Title		TDA2022M AMPLIFIER FOR CENTER & BASS	
Size	Number	Revision	
A4	NO.2		
Date:		1-30-2004	
Drawn By:		SHEEP	
Sheet of		4	

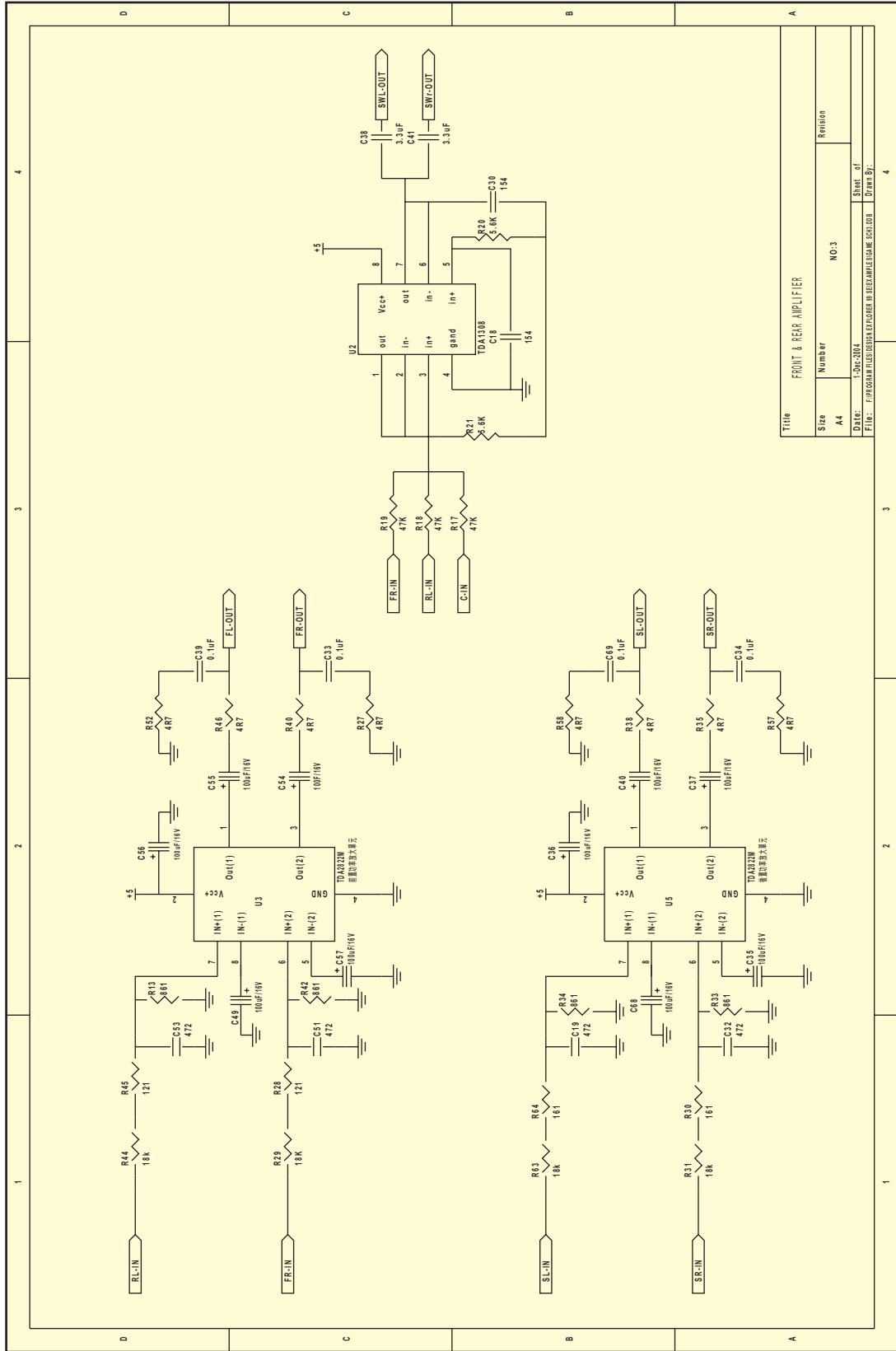

Title		FRONT & REAR AMPLIFIER	
Size	Number	NO:3	Revision
A4			
DATE: 1 Dec 2011	SWR: J1		
FILE: F:\PROGRAM FILES\PROFESSOR\PROFESSOR\DESIGN\PCB\CP5.1.DWG	DATE BY: J1		

Acoustic Characteristic 音響特性

	Characteristic	Front Speaker	Rear Speaker	Center Speaker	Bass Speaker
1.	Frequency Range	20Hz~20kHz	20Hz~20kHz	20Hz~20kHz	20Hz~3kHz
2.	Sensitivity	97± 3dB	97± 3dB	97± 3dB	121± 3dB
3.	Speaker Type & Size	∅27mm Dynamic	∅27mm Dynamic	∅27mm Dynamic	∅30mm Dynamic
4.	Normal Impedance	32Ω	32Ω	32Ω	24Ω
5.	Output Power	150mW	150mW	100mW	15mW (max 100mW)

Speaker
Frequency Response
頻率響應圖

Speaker: **Front & Rear** Model: CP5.1 GAME
Voltage applied for F.R.: 0.178V
Measure distance: 0.01m

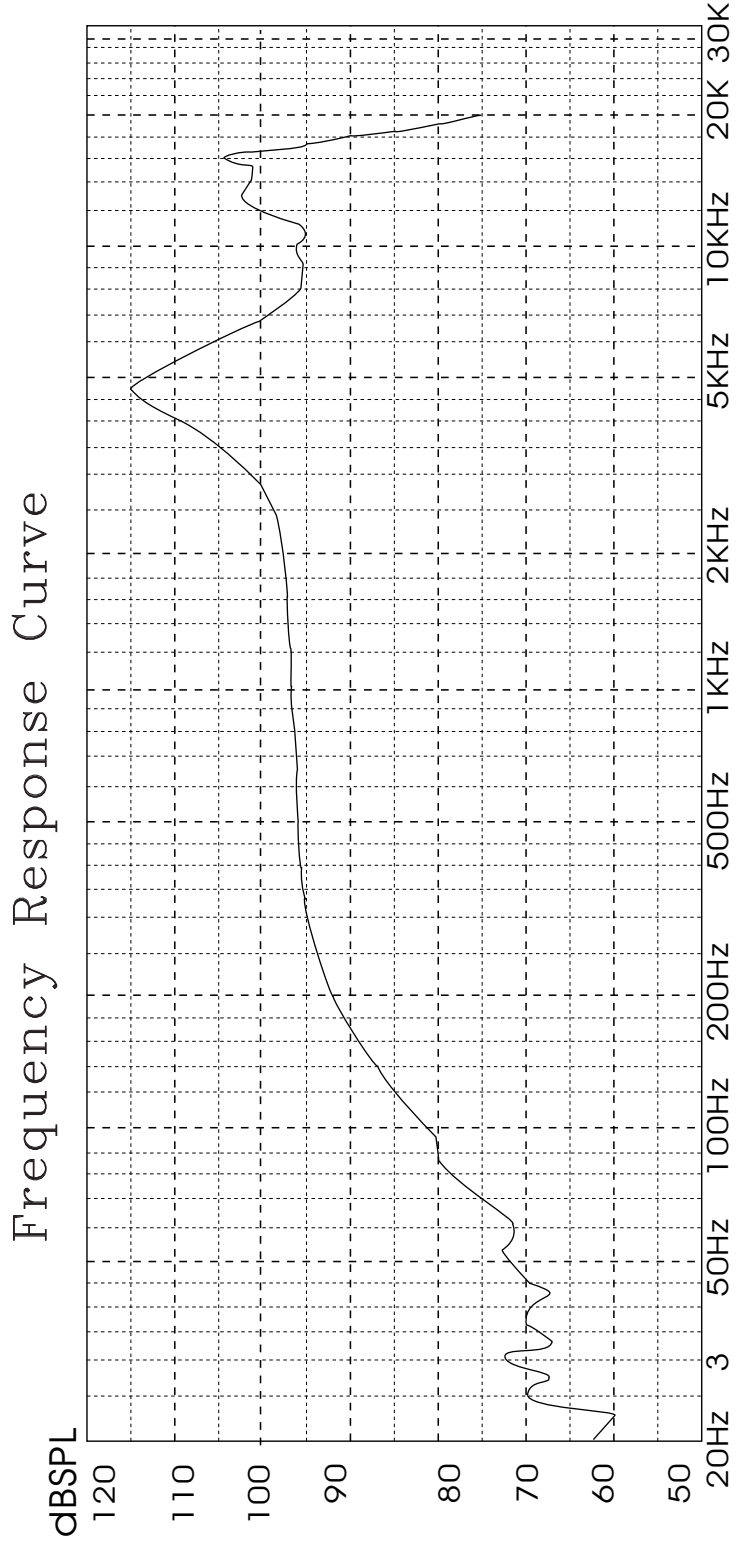

Speaker: **Center** Model: CP5.1 GAME
Voltage applied for F.R.=0.126V
Measure distance: 0.01m

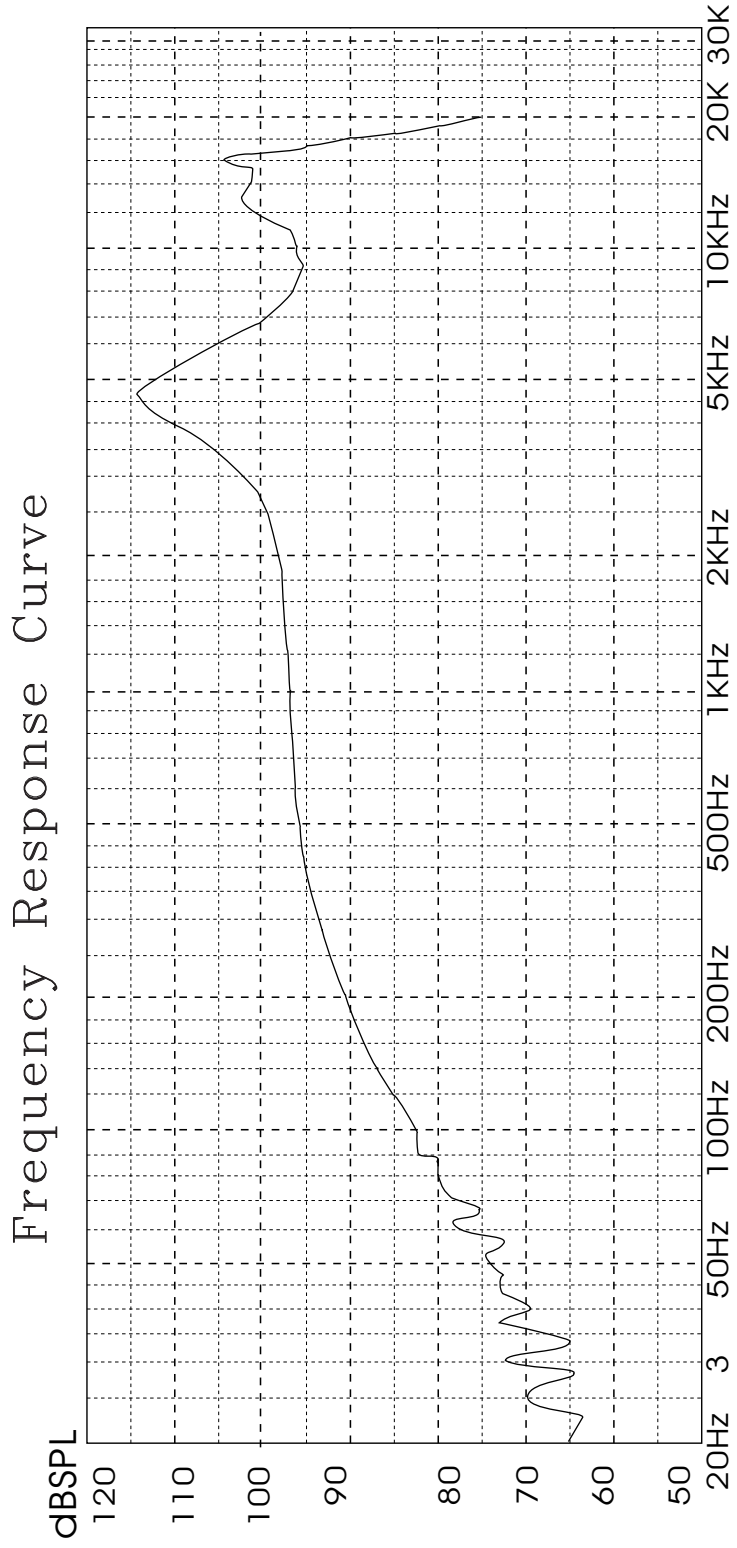

Speaker:**Bass** Model:CP5.1 GAME
Voltage applied for F.R.=0.155V
Measure distance:0.01m

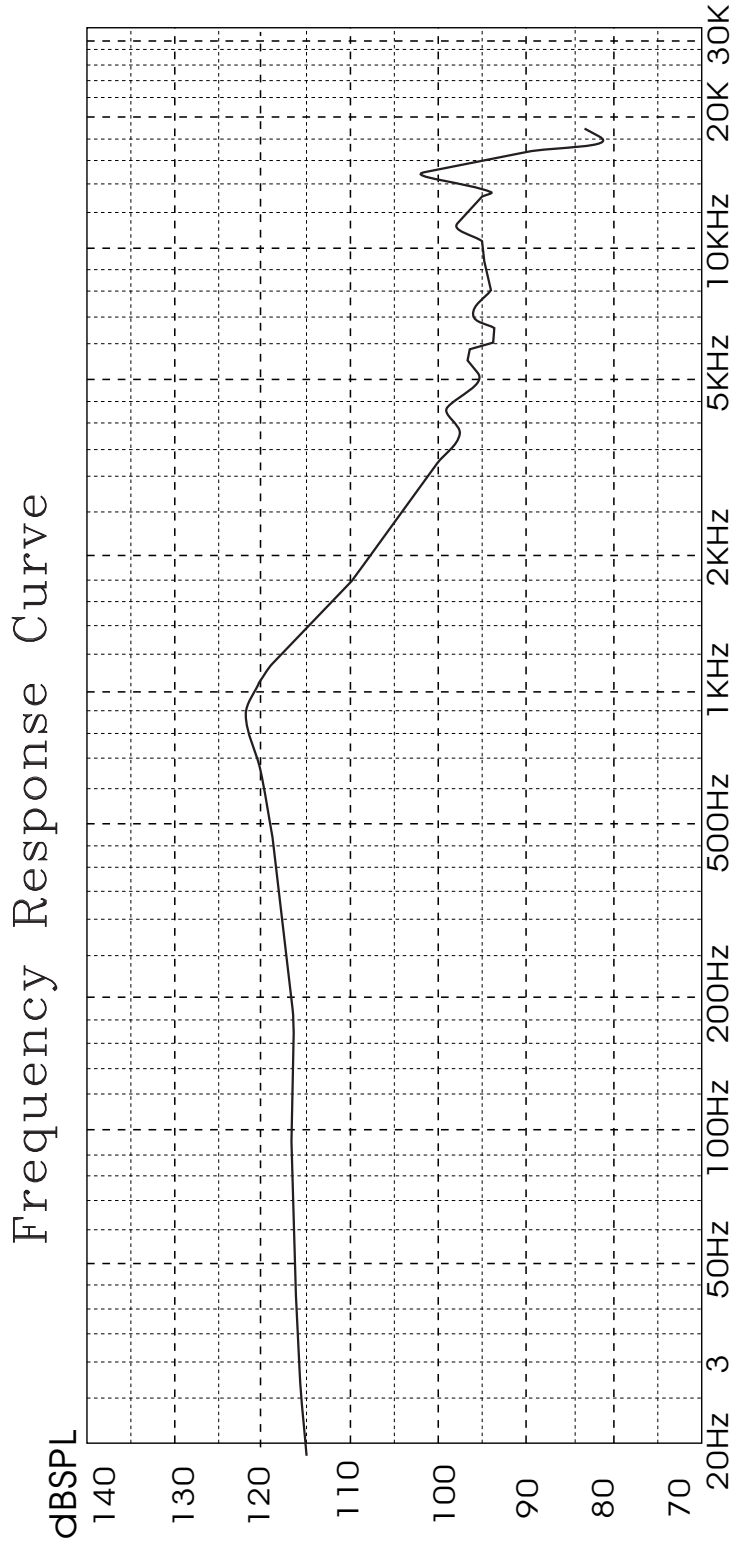

Electrical Characteristics 電氣特性

Characteristic

1.	電源電壓 Supply Voltage	DC5V
2.	靜態消耗電流 Quiescent Drain Current	≤ 0.1 A
3.	最大消耗電流 Max Drain Current	≤ 1.3 A
4.	總諧波失真 Total Hharmonic Distortion	$\leq 5\%$
5.	動態範圍 Dynamic Range	100dB
6.	平衡度 Channel Unbalance	≥ 2 dB
7.	分離度 Separation	≤ 100 dB
8.	信噪比 S/N	85dB
8.	阻尼係數 Damping Factor	20

Packaging
包裝

FRONT VIEW



BACK VIEW

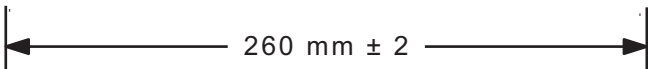
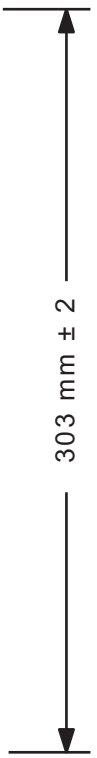

Side View

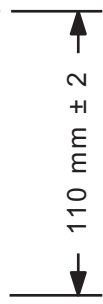

Packaging Construction

包裝方法示意圖

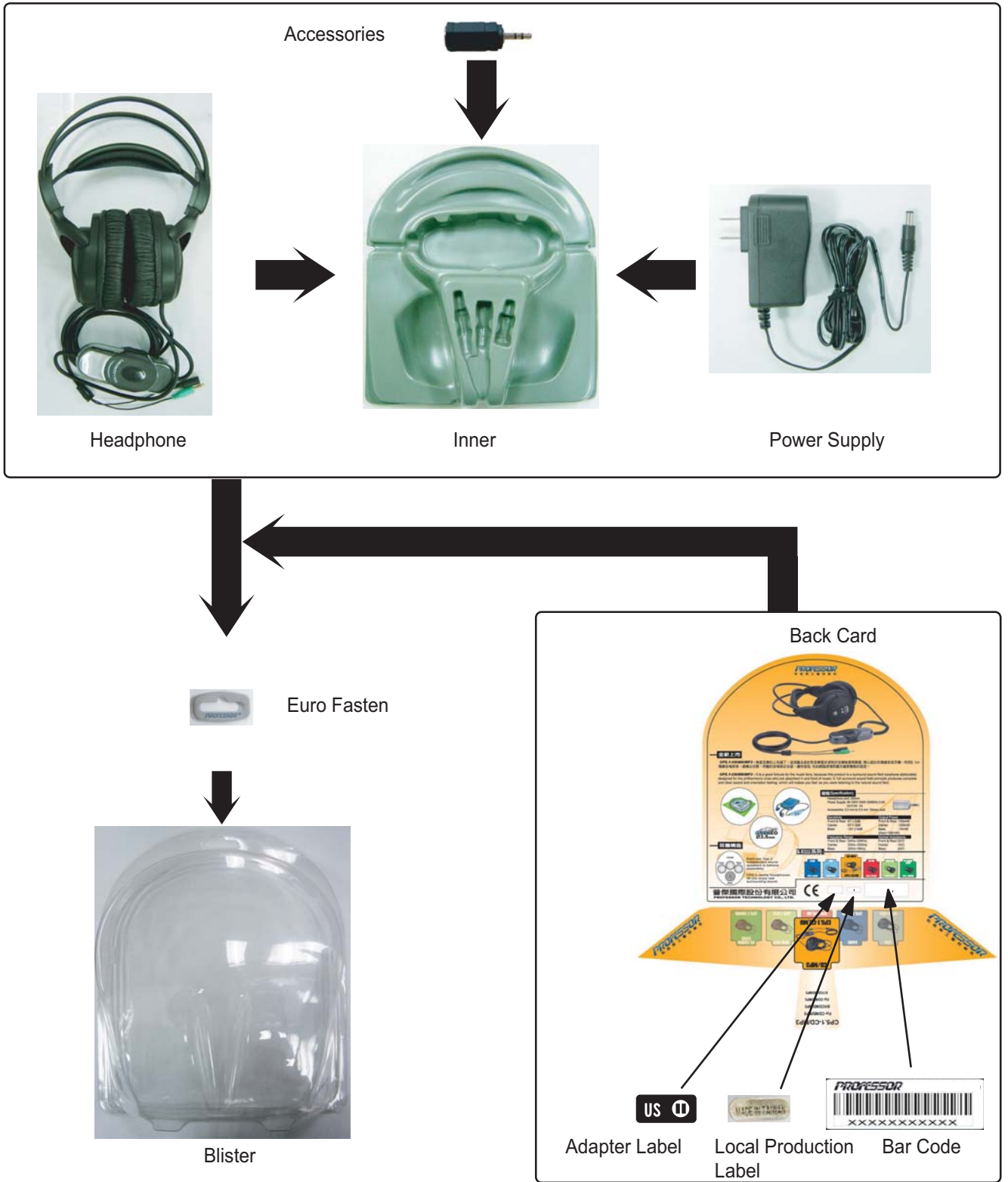

Carton Packaging Construction 外箱包裝

