



普傑國際股份有限公司

PROFESSOR TECHNOLOGY CO., LTD.

## PRODUCT SPECIFICATION

### 產品承認書

Customer: \_\_\_\_\_

Product Name: **5.1 Channel Surround Headphone.**

Model No: **CP5.1-PC/NB**

Production Region: **China**

Version: **English**

Customer Approval Stamp.

Date: \_\_\_ / \_\_\_ / \_\_\_.

Contact Info: Jimmy Chan  
+886-3-4551081 ext:209  
jimmychan@professor.com.tw  
jack@professor.com.tw

Model No:

CP5.1-PC/NB

Date:

30/Nov/2004

Checked by:

Approved by:

**PROFESSOR TECHNOLOGY CO., LTD.**

5F, No.25-1, JiLin Rd., Chung-Li Industrial Park, Taoyuan 320, Taiwan.

TEL :+886-3-4551081 FAX :+886-3-4553913

## Specification 規格

Part	Description	Qty.
1.	Driver Front: 27mm Dynamic Speaker 32 Ohm 150mW Rear: 27mm Dynamic Speaker 32 Ohm 150mW Center: 27mm Dynamic Speaker 32 Ohm 100mW Bass: 30mm Dynamic Speaker 24 Ohm 15mW	2 2 2 2
2.	Processor Input: AC100~240V 50/60Hz Output: DC+5V 1A	1
3.	Headphone type Closed Air type.	
4.	Cable & Connector Cord Length: 240 cm Connector: $\phi$ 3.5mm stereo plug green color. DC Jack 2.5mm black color Accessories : $\phi$ 3.5mm to $\phi$ 2.5mm Stereo connector	1 1 1 1
5.	Weight Gross Weight: 660 g (include accessories and package) Net Weight: 470 g (only headphone)	
6.	Package type Blister	1
7.	Power Supply Input: AC100~240V 50/60Hz Output: DC+5V 1A DC plug: OD=5.5mm ID=2.7mm	1
8.	Microphone Size: $\phi$ 6 mm x 5mm Sensitivity: $-62 \pm 2$ dB	1

## Cosmetic List 外觀圖清單

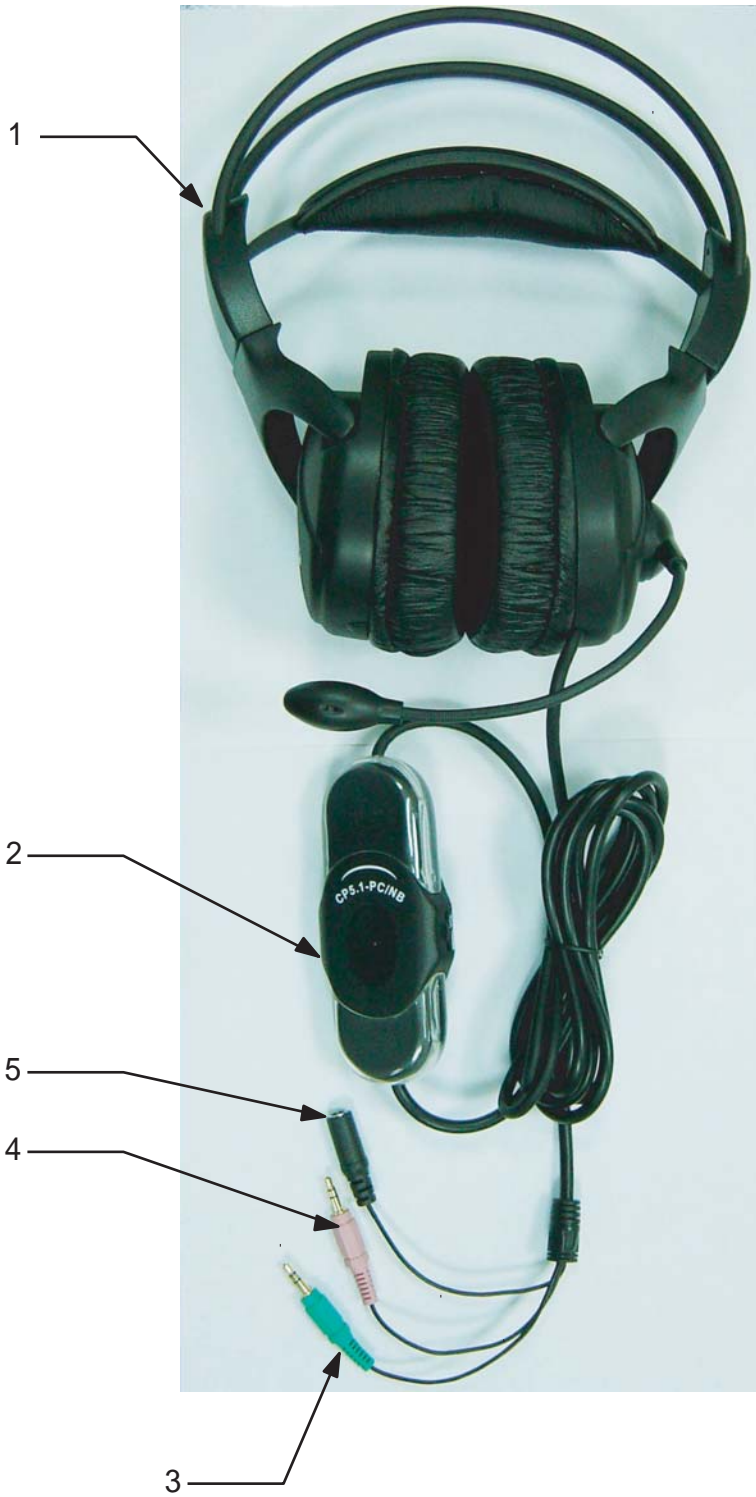

Power Supply



UK

1. Headphone
2. Control Box (Processor) with Volume control.
3. Stereo plug (Green)
4. Stereo plug (Pink)
5. DC Jack

# Circuit Diagram 電路圖

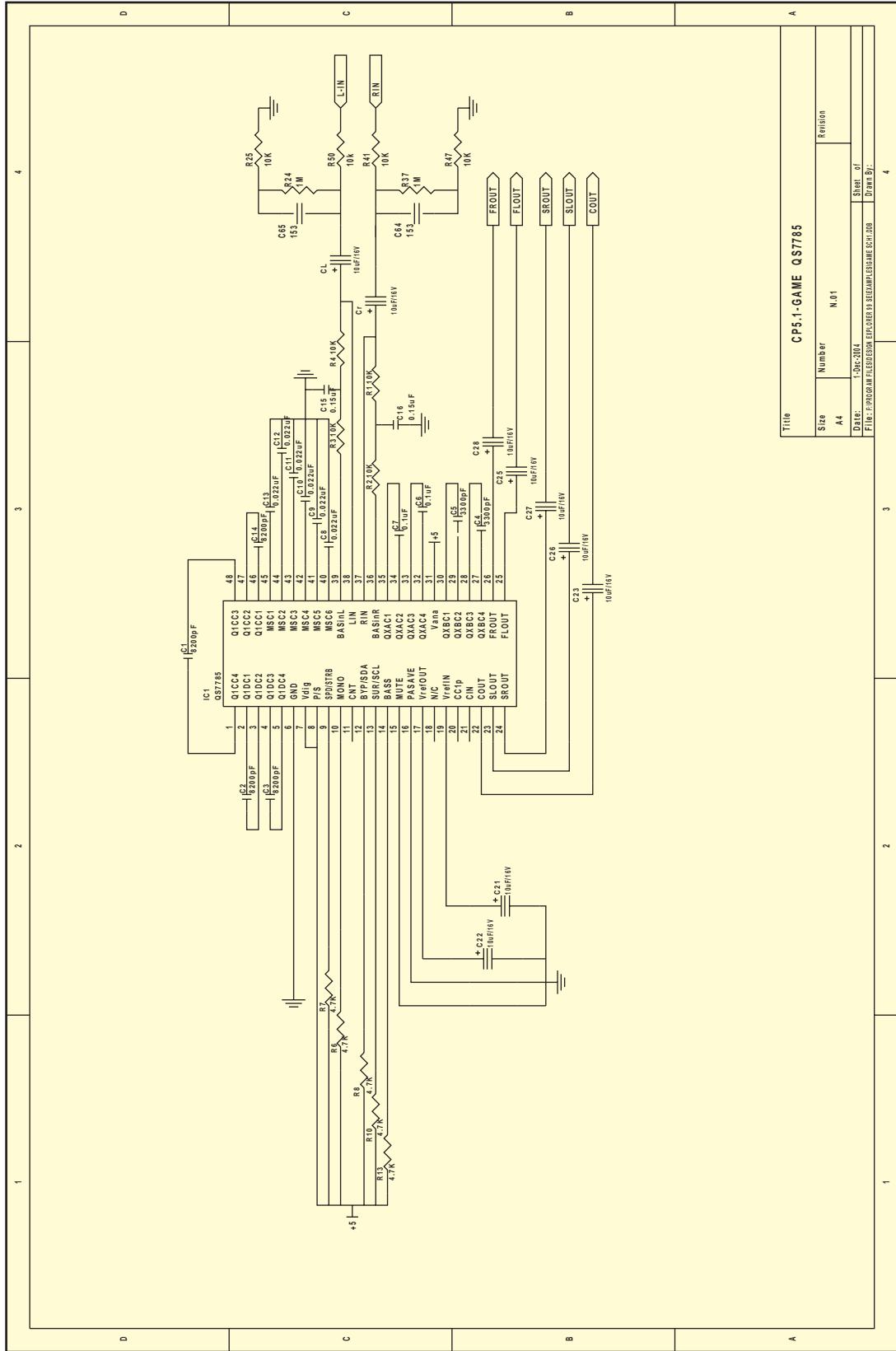

Title		CPS.1-GAME Q57785	
Size	Number	Revision	
A4	N.01		
DATE:	1 Dec 2001	STATUS:	1
FILE: PROGRAM FILE	DESIGNER: H. YAMAMOTO	DATE:	1
		DATE:	1

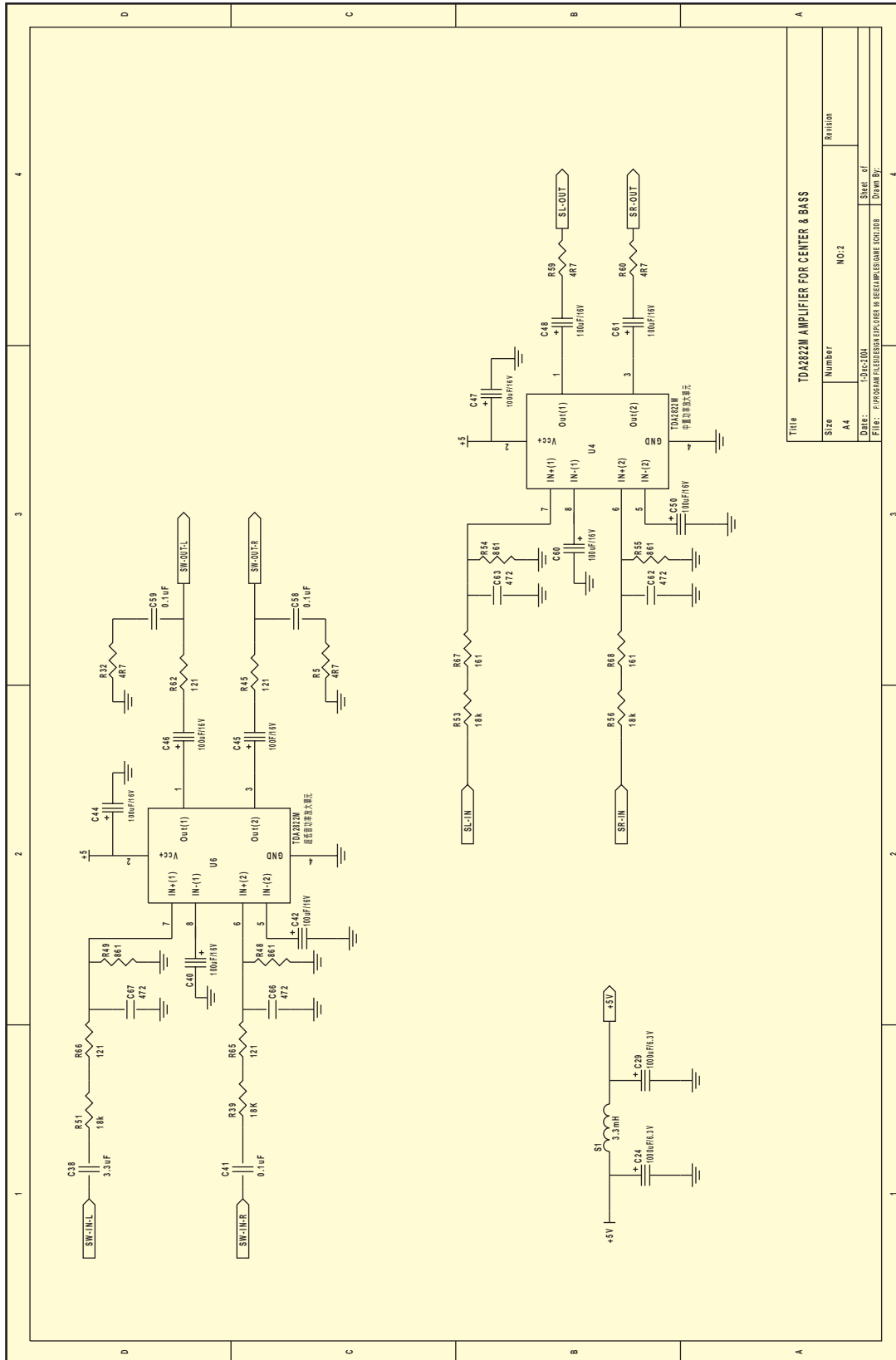

Title		TD4322M AMPLIFIER FOR CENTER & BASS	
Size	Number	Revision	
A4	NO.2		
Date:		1-10-2004	
Drawn By:		程文龍	
Sheet of		4	

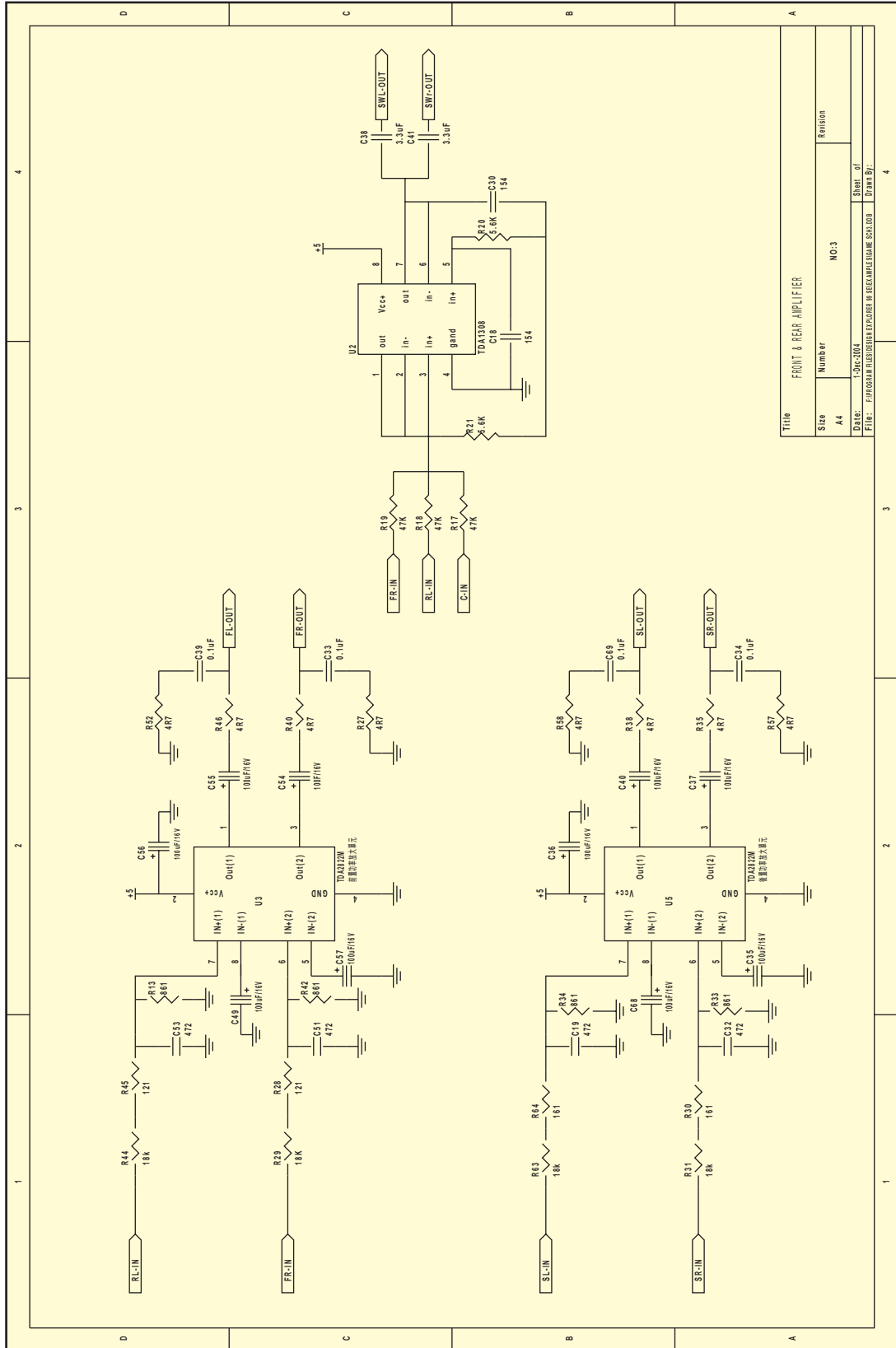

## Acoustic Characteristic 音響特性

	Characteristic	Front Speaker	Rear Speaker	Center Speaker	Bass Speaker
1.	Frequency Range	20Hz~20kHz	20Hz~20kHz	20Hz~20kHz	20Hz~3kHz
2.	Sensitivity	97± 3dB	97± 3dB	97± 3dB	121± 3dB
3.	Speaker Type & Size	∅27mm Dynamic	∅27mm Dynamic	∅27mm Dynamic	∅30mm Dynamic
4.	Normal Impedance	32Ω	32Ω	32Ω	24Ω
5.	Output Power	150mW	150mW	100mW	15mW (max 100mW)

Speaker  
Frequency Response  
頻率響應圖

Speaker: Front & Rear      Model: CP5.1 GAME  
Voltage applied for F.R.: 0.178V  
Measure distance: 0.01m

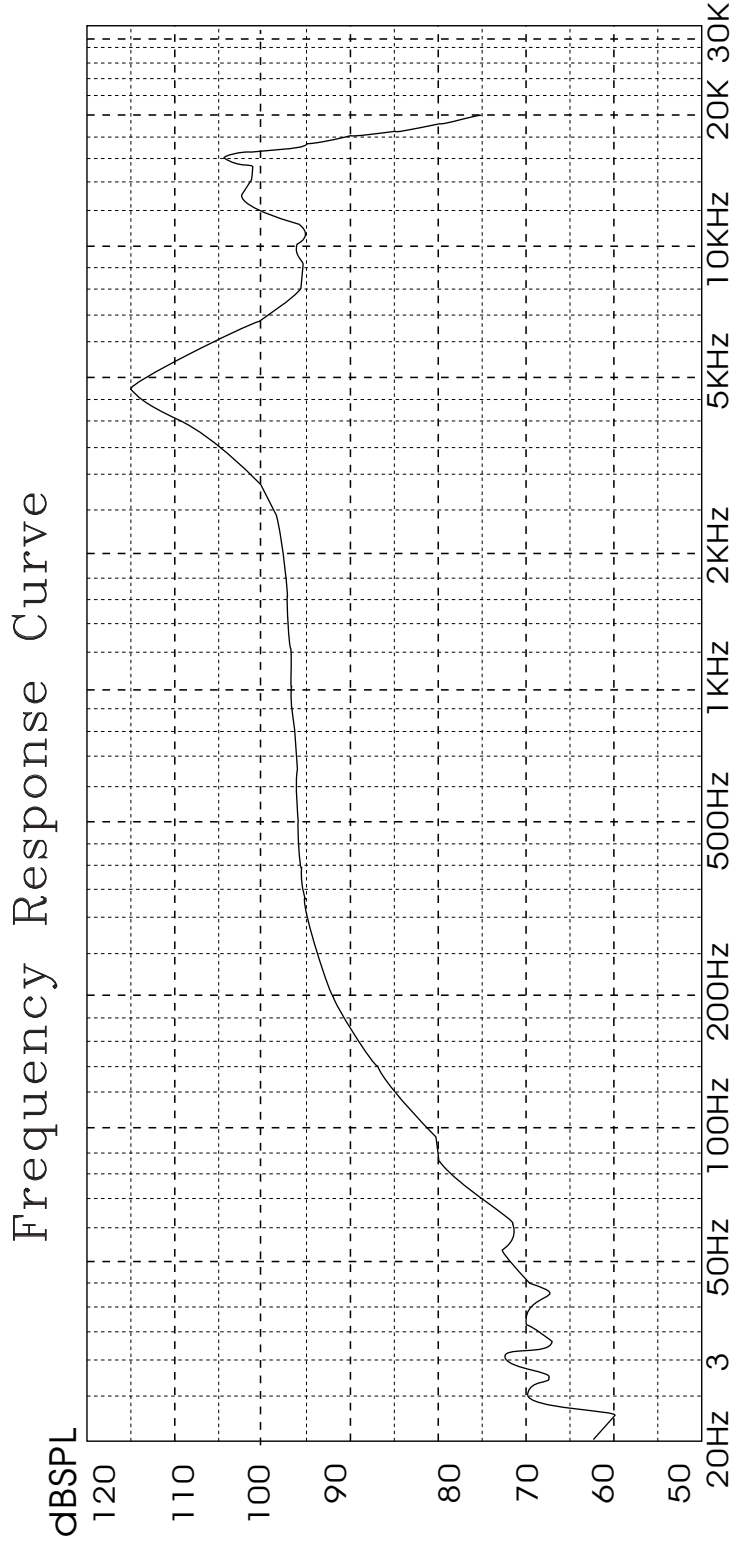

Speaker: **Center** Model: CP5.1 GAME  
Voltage applied for F.R. = 0.126V  
Measure distance: 0.01m

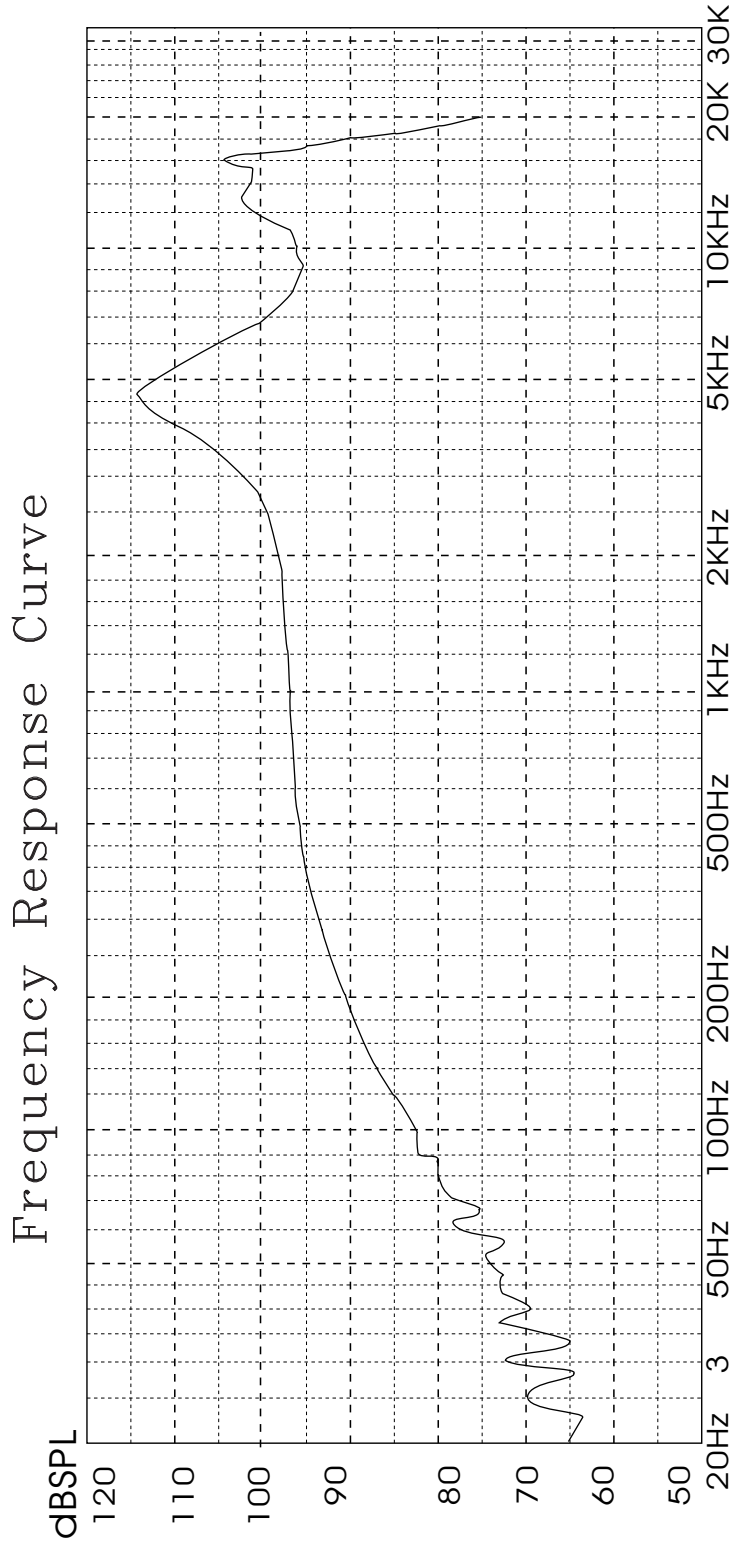

Speaker:**Bass** Model:CP5.1 GAME  
Voltage applied for F.R.=0.155V  
Measure distance:0.01m

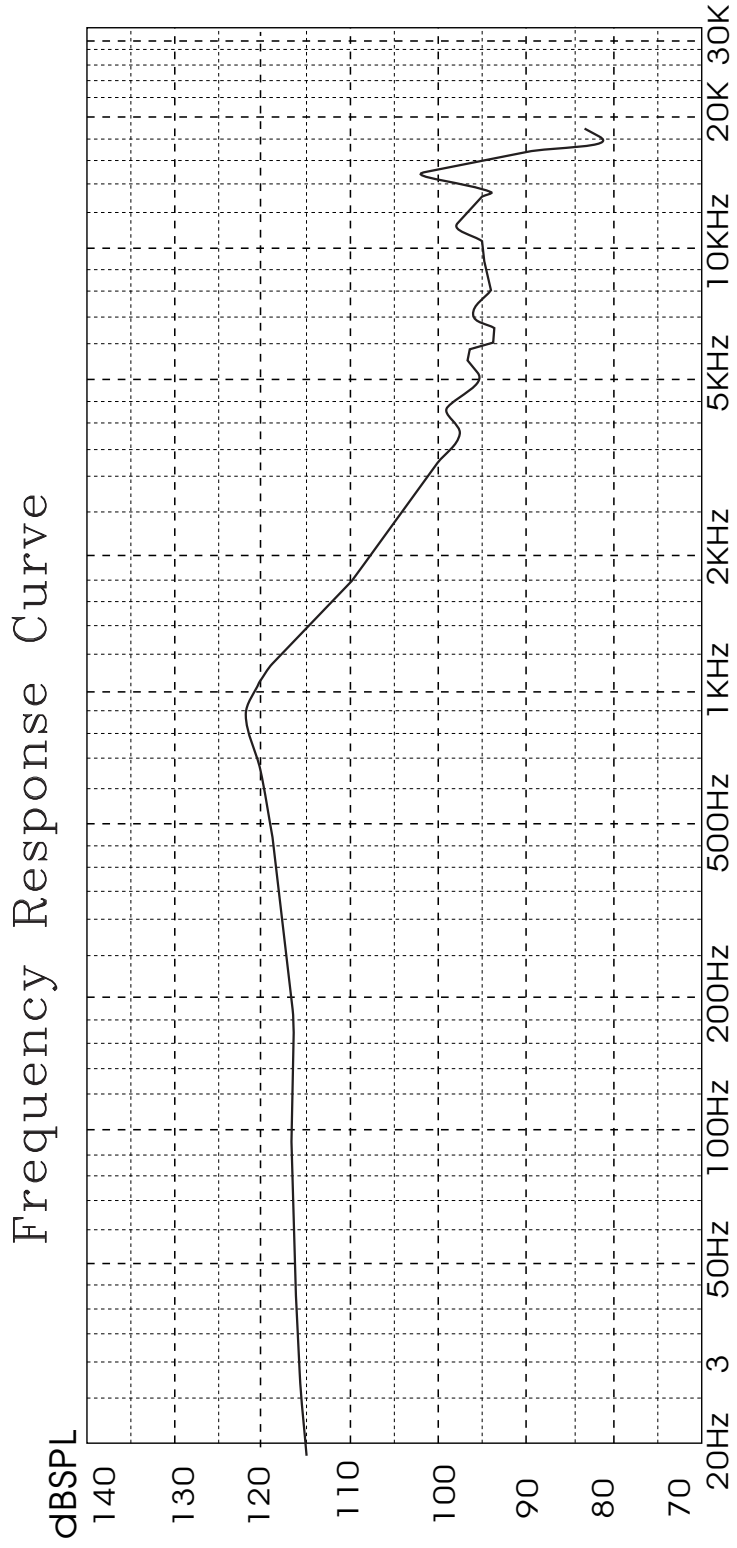

## Electrical Characteristics 電氣特性

### Characteristic

1.	電源電壓 Supply Voltage	DC5V
2.	靜態消耗電流 Quiescent Drain Current	<0.1 A
3.	最大消耗電流 Max Drain Current	<1.3 A
4.	總諧波失真 Total Harmonic Distortion	<5%
5.	動態範圍 Dynamic Range	100dB
6.	平衡度 Channel Unbalance	>2dB
7.	分離度 Separation	<100dB
8.	信噪比 S/N	85dB
8.	阻尼係數 Damping Factor	20

**Packaging  
包裝**

FRONT VIEW



BACK VIEW

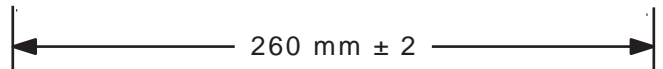
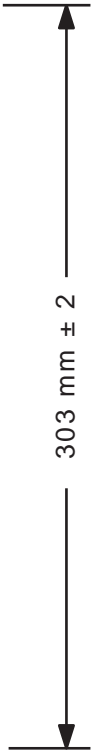

Side View

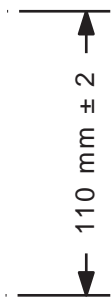

## Packaging Construction 包裝方法示意圖

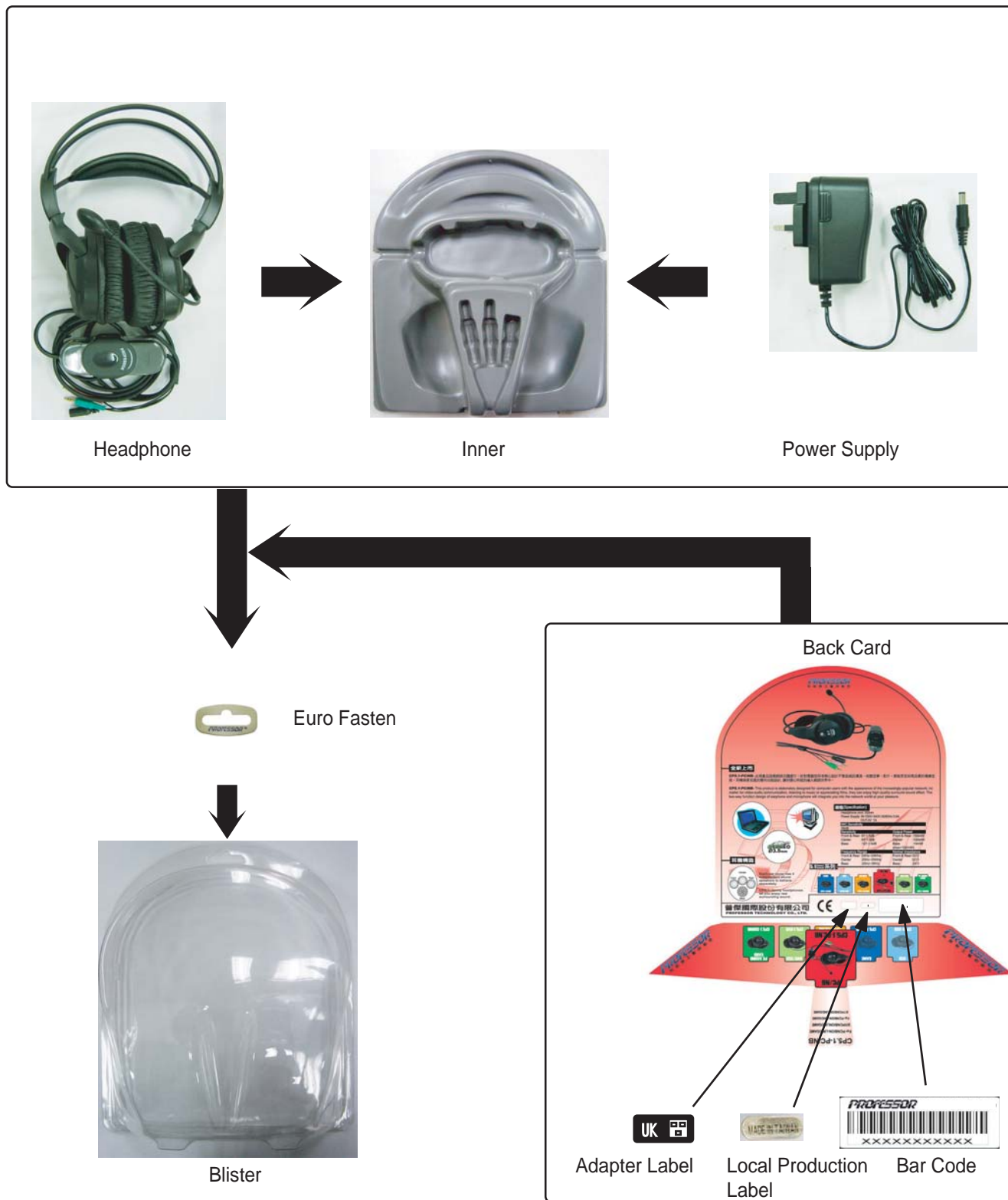

# Carton Packaging Construction 外箱包裝

