



普傑國際股份有限公司

PROFESSOR TECHNOLOGY CO., LTD.

PRODUCT SPECIFICATION

產品承認書

Customer: _____

Product Name: **5.1 Channel Surround Headphone.**

Model No: **CP5.1-PC/NB**

Production Region: **China**

Version: **English**

Customer Approval Stamp.

Date: ___ / ___ / ___.

Contact Info: Jimmy Chan
+886-3-4551081 ext:209
jimmychan@professor.com.tw
jack@professor.com.tw

Model No:

CP5.1-PC/NB

Date:

30/Nov/2004

Checked by:

Approved by:

PROFESSOR TECHNOLOGY CO., LTD.

5F, No.25-1, JiLin Rd., Chung-Li Industrial Park, Taoyuan 320, Taiwan.

TEL :+886-3-4551081 FAX :+886-3-4553913

Specification 規格

Part	Description	Qty.
1.	Driver Front: 27mm Dynamic Speaker 32 Ohm 150mW Rear: 27mm Dynamic Speaker 32 Ohm 150mW Center: 27mm Dynamic Speaker 32 Ohm 100mW Bass: 30mm Dynamic Speaker 24 Ohm 15mW	2 2 2 2
2.	Processor Input: AC100~240V 50/60Hz Output: DC+5V 1A	1
3.	Headphone type Closed Air type.	
4.	Cable & Connector Cord Length: 240 cm Connector: ϕ 3.5mm stereo plug green color. DC Jack 2.5mm black color Accessories : ϕ 3.5mm to ϕ 2.5mm Stereo connector	1 1 1 1
5.	Weight Gross Weight: 660 g (include accessories and package) Net Weight: 470 g (only headphone)	
6.	Package type Blister	1
7.	Power Supply Input: AC100~240V 50/60Hz Output: DC+5V 1A DC plug: OD=5.5mm ID=2.7mm	1
8.	Microphone Size: ϕ 6 mm x 5mm Sensitivity: -62 ± 2 dB	1

Cosmetic List 外觀圖清單

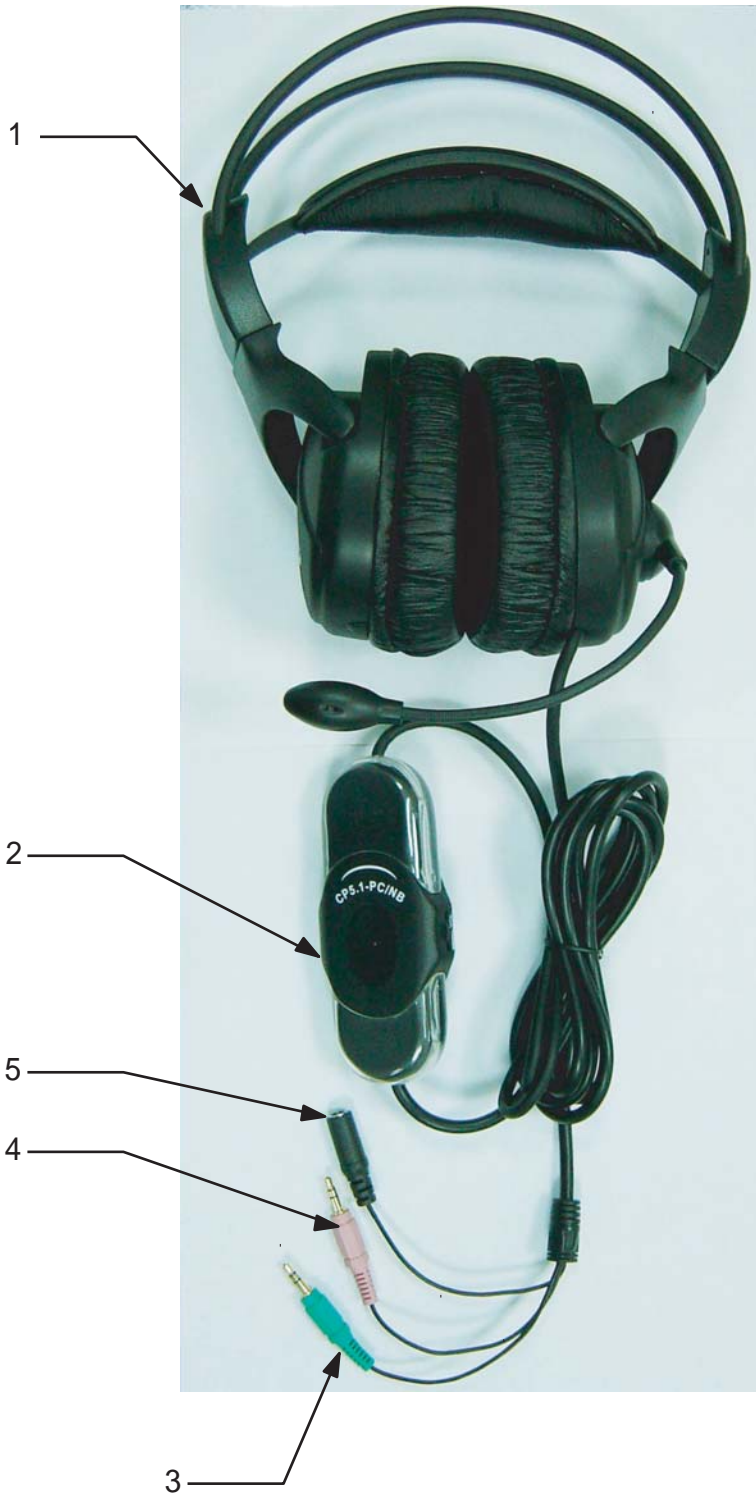

Power Supply



GS

1. Headphone
2. Control Box (Processor) with Volume control.
3. Stereo plug (Green)
4. Stereo plug (Pink)
5. DC Jack

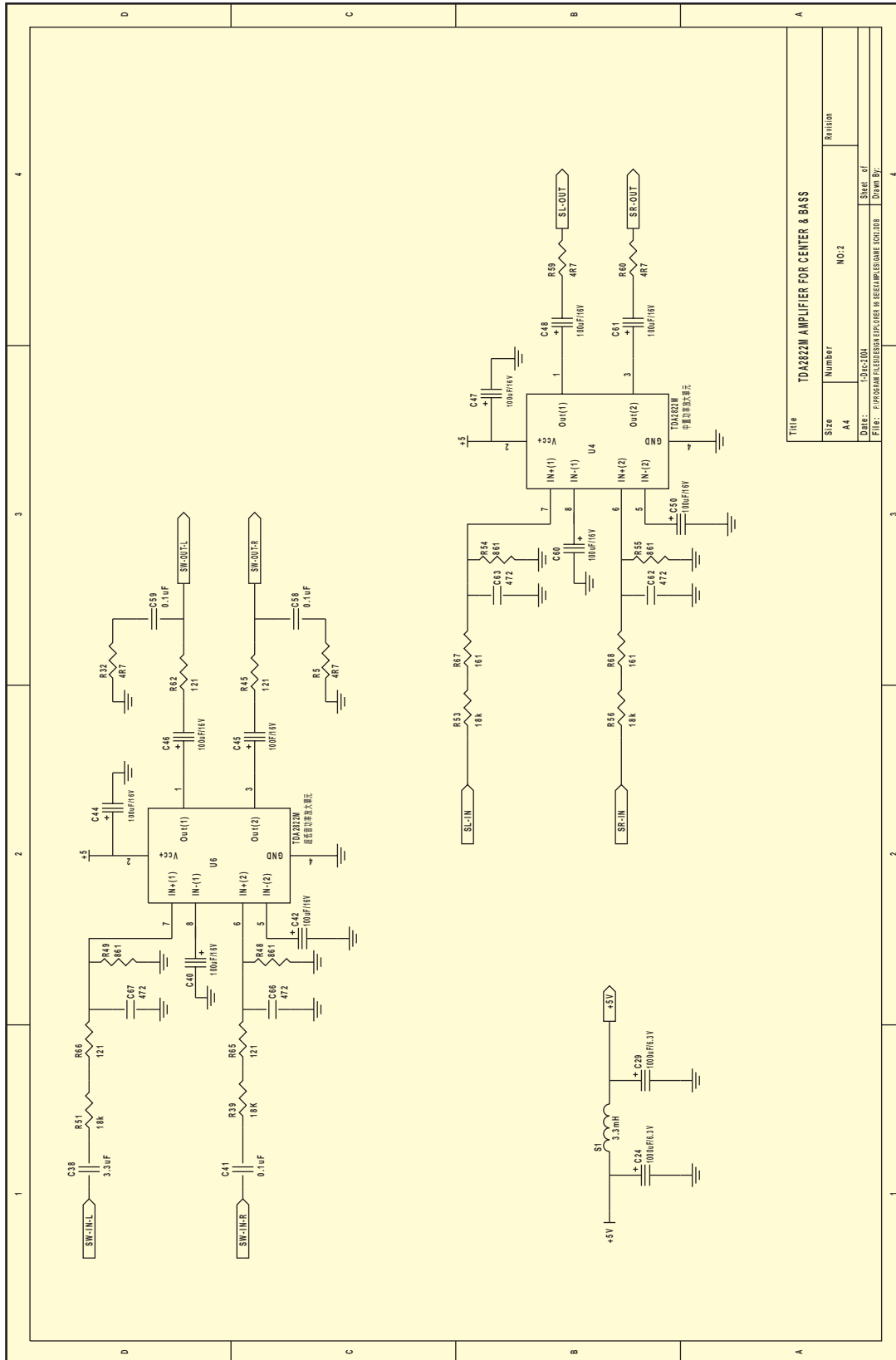

Title		TD4322M AMPLIFIER FOR CENTER & BASS	
Size	Number	Revision	
A4	NO.2		
Date:		1-10-2004	
Drawn By:		程文輝	
Sheet of		4	

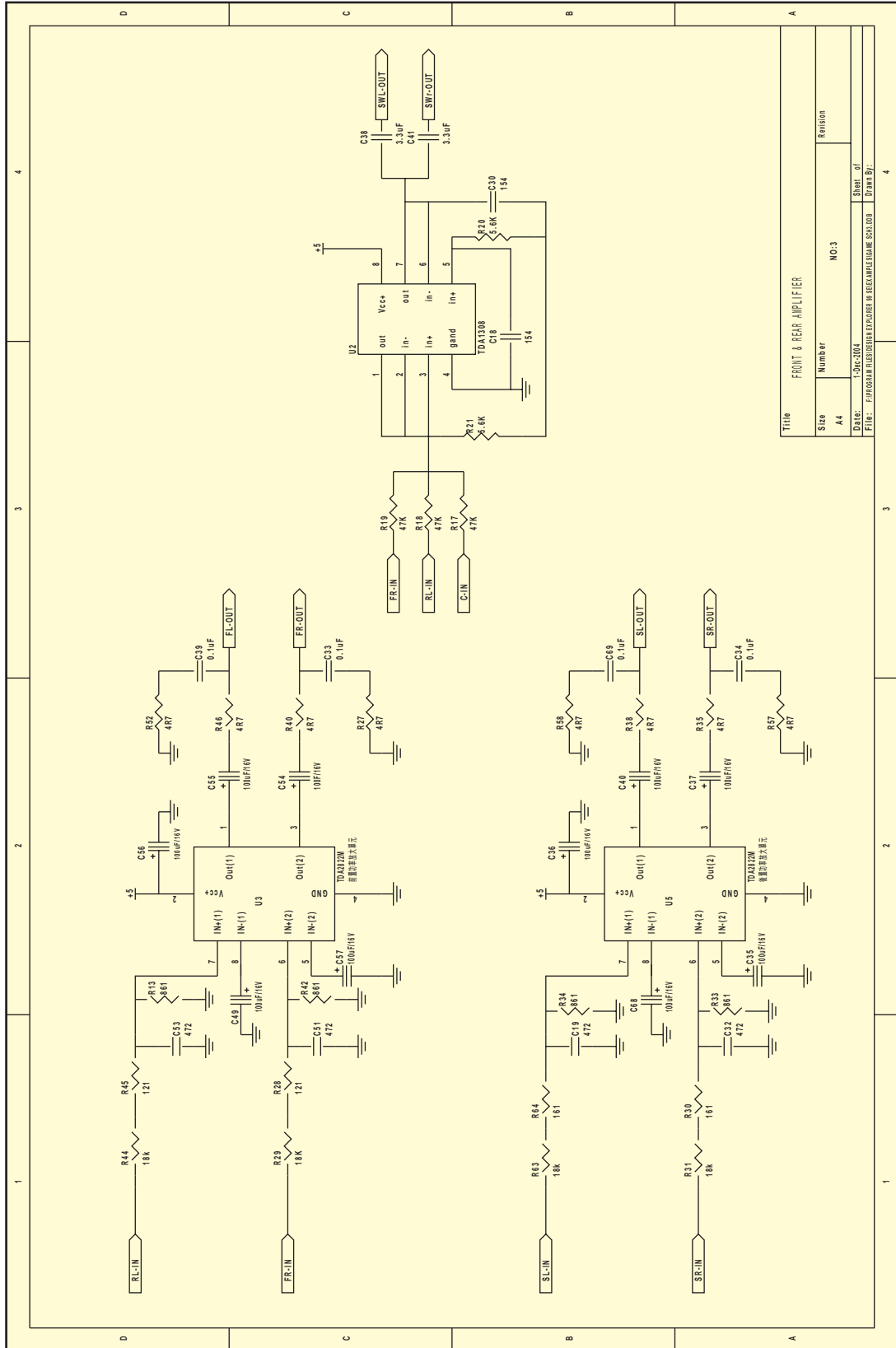

Title		FRONT & REAR AMPLIFIER	
Size	Number	NO.3	Revision
A4			
DATE:	1.04.2011	SWR-DJ	
FILE:	F:\PROGRAM FILES\PROFESSOR\PROFESSOR\PROFESSOR\PROFESSOR\PROFESSOR.DWG	DATE BY:	

Acoustic Characteristic 音響特性

	Characteristic	Front Speaker	Rear Speaker	Center Speaker	Bass Speaker
1.	Frequency Range	20Hz~20kHz	20Hz~20kHz	20Hz~20kHz	20Hz~3kHz
2.	Sensitivity	97± 3dB	97± 3dB	97± 3dB	121± 3dB
3.	Speaker Type & Size	∅27mm Dynamic	∅27mm Dynamic	∅27mm Dynamic	∅30mm Dynamic
4.	Normal Impedance	32Ω	32Ω	32Ω	24Ω
5.	Output Power	150mW	150mW	100mW	15mW (max 100mW)

Speaker
Frequency Response
頻率響應圖

Speaker: Front & Rear Model: CP5.1 GAME
Voltage applied for F.R.: 0.178V
Measure distance: 0.01m

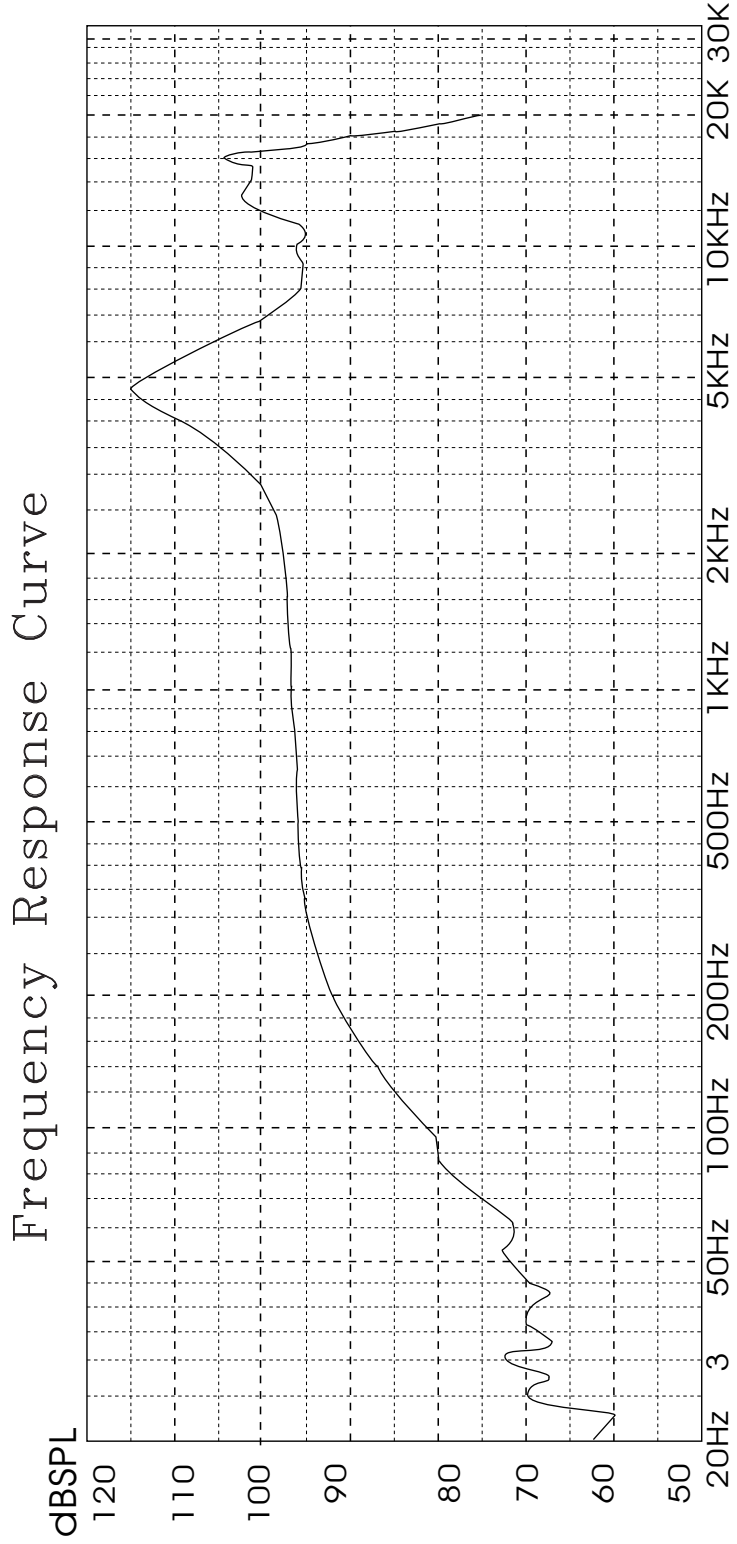

Speaker: **Center** Model: CP5.1 GAME
Voltage applied for F.R. = 0.126V
Measure distance: 0.01m

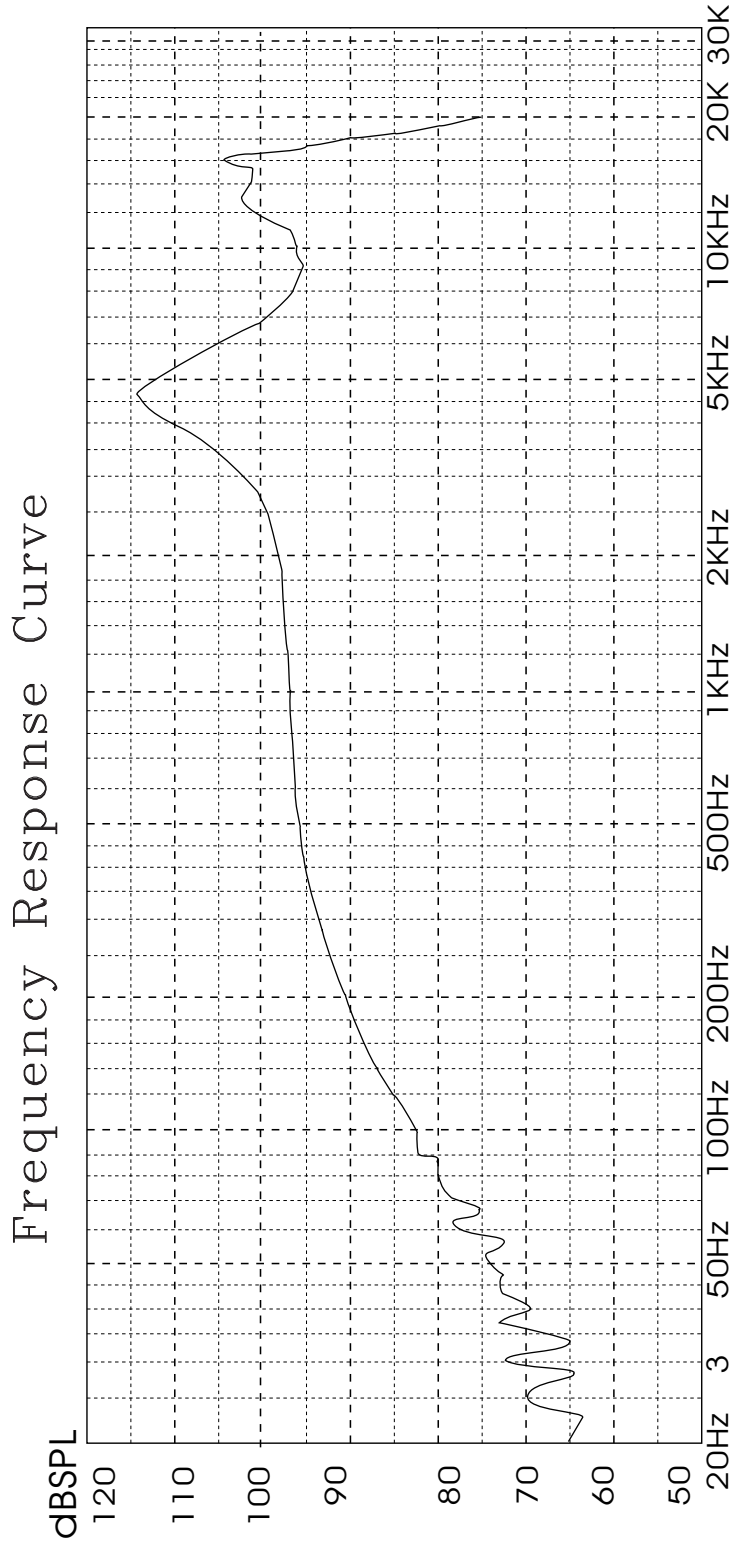

Speaker: **Bass** Model: CP5.1 GAME
Voltage applied for F.R.=0.155V
Measure distance: 0.01m

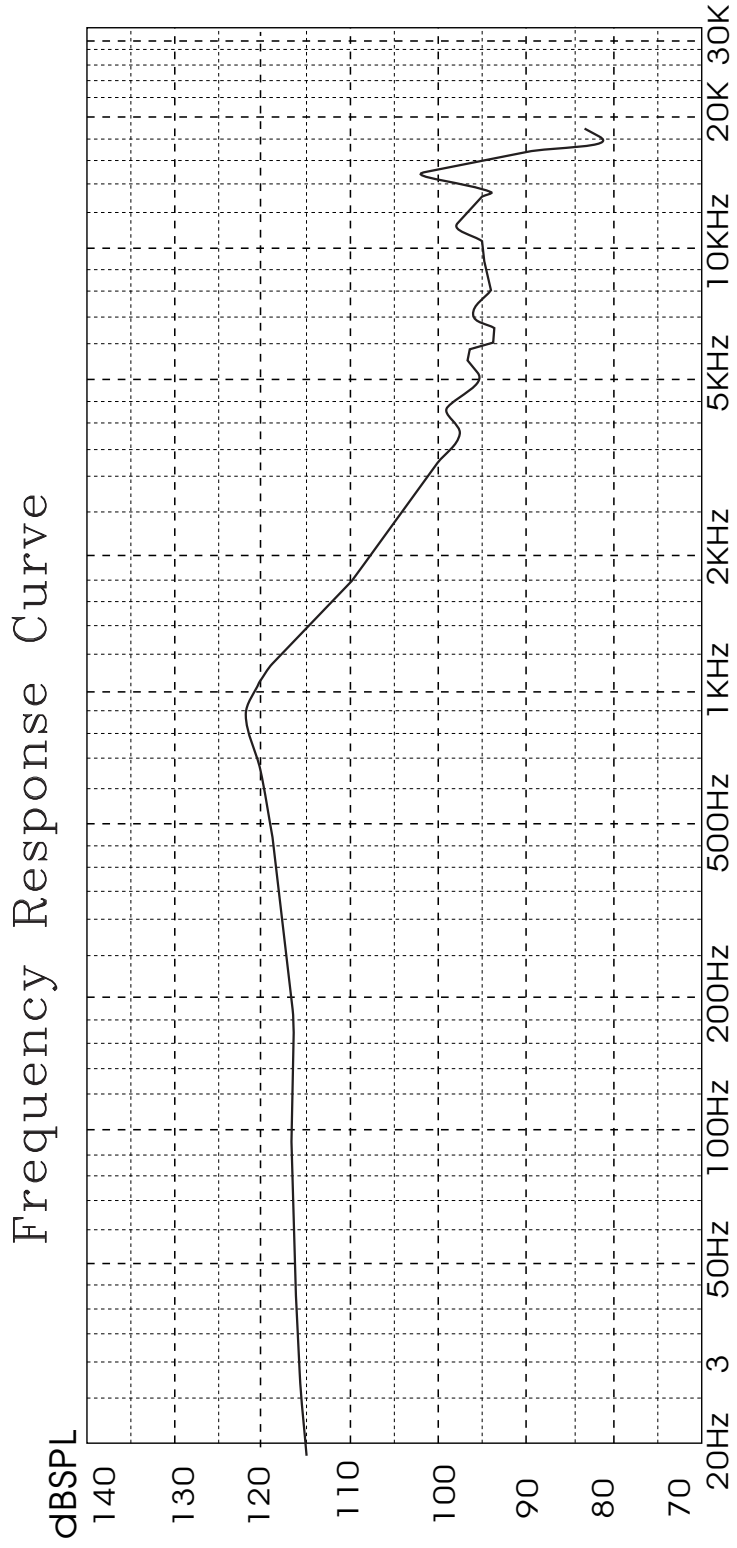

Electrical Characteristics 電氣特性

Characteristic

1.	電源電壓 Supply Voltage	DC5V
2.	靜態消耗電流 Quiescent Drain Current	<0.1 A
3.	最大消耗電流 Max Drain Current	<1.3 A
4.	總諧波失真 Total Harmonic Distortion	<5%
5.	動態範圍 Dynamic Range	100dB
6.	平衡度 Channel Unbalance	>2dB
7.	分離度 Separation	<100dB
8.	信噪比 S/N	85dB
8.	阻尼係數 Damping Factor	20

Packaging
包裝

FRONT VIEW



BACK VIEW



303 mm ± 2

260 mm ± 2

Side View

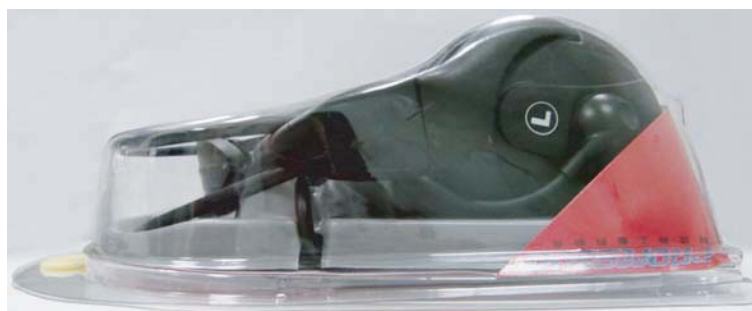

110 mm ± 2

Packaging Construction
包裝方法示意圖

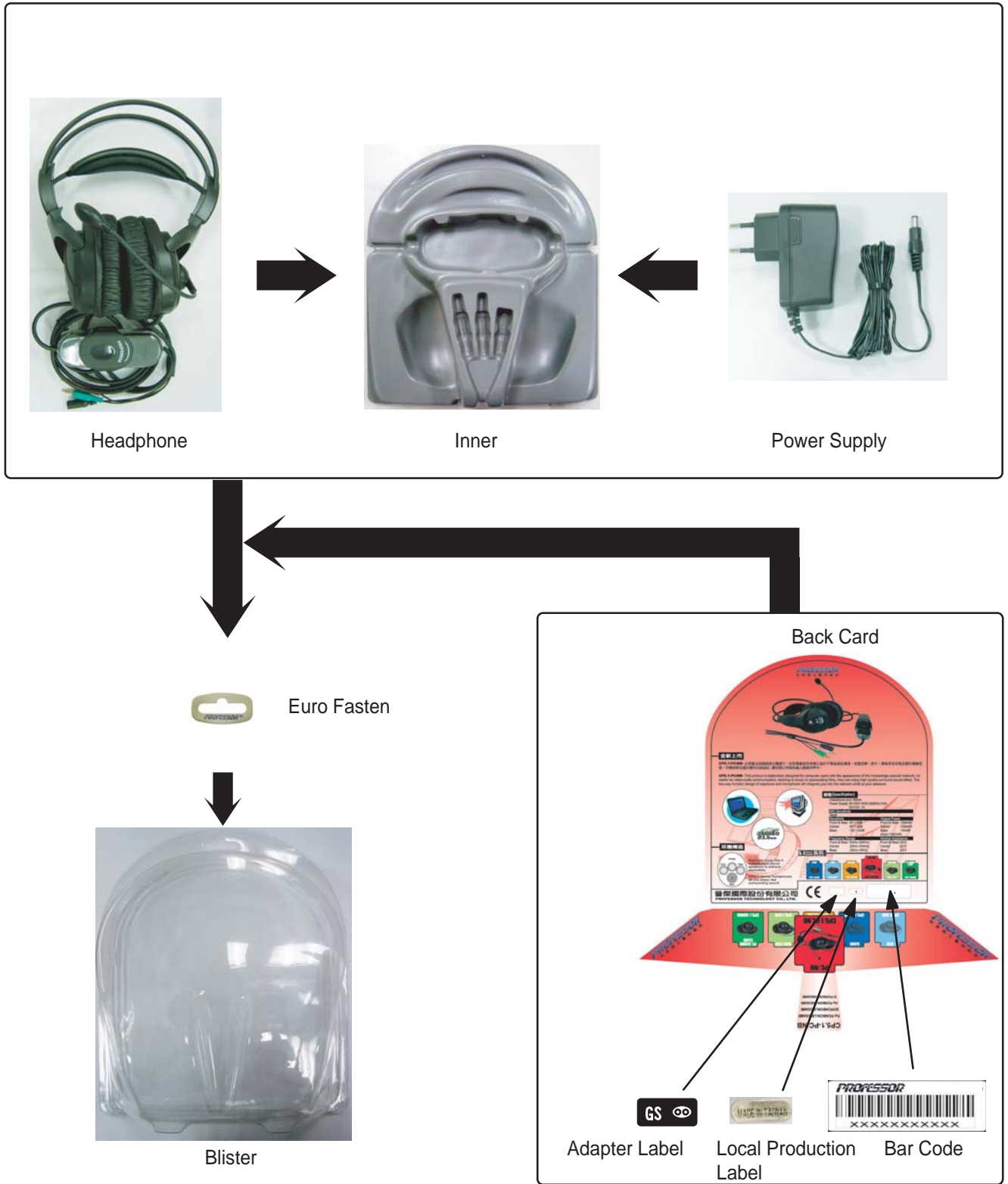

Carton Packaging Construction 外箱包裝

